

## DATA SHEET

### MODULETEK: SFP-10G-CWDM-ER-xxxx-CDR-x-E10

10GBASE CWDM 40km SFP+ Transceiver

#### SFP-10G-CWDM-ER-xxxx-CDR-x-E10 Overview

ModuleTek's SFP-10G-CWDM-ER-xxxx-CDR-x-E10 SFP+ optical transceivers are based on 10G Ethernet and SFF-8431 standard, providing a fast and reliable interface for 10G Ethernet applications. The product is available in 8 different CWDM wavelengths (20nm wavelength interval) from 1471nm to 1611nm, digital diagnostics via a 2-wire serial bus, compliant with the SFF-8472 standard.

#### Product Features

- Dual CDR from 9.95 to 11.3Gb/s bi-directional data links
- Compliant with IEEE 802.3ae 10GBASE-ER/EW
- Compliant with 10GFC
- Compliant with SFF-8431
- Hot-pluggable SFP+ footprint
- Temperature-stabilized CWDM EML laser
- Receiver with PIN
- Duplex LC connector
- Built-in digital diagnostic functions
- Up to 40km on SMF
- Single power supply 3.3V
- Low power consumption
- RoHS Compliant
- Operating temperature range (Case Temperature) : Commercial Level : 0°C to 70°C  
Industrial Level : - 40°C to 85°C



#### Applications

- 10GBASE-ER/EW Ethernet
- 10G FC

## Ordering Information

Part Number	Product ID	Description
SFP-10G-CWDM-ER-xxxx-CDR-C-E10	M444501	10GBASE CWDM SFP+ Transceiver, LC Connectors, Single Mode Fiber 40km, Commercial temperature
SFP-10G-CWDM-ER-xxxx-CDR-I-E10	M444502	10GBASE CWDM SFP+ Transceiver, LC Connectors, Single Mode Fiber 40km, Industrial temperature
<b>Note:</b> 1.Product ID is the abbreviated order number of our company's standard model		

### For More Information:

ModuleTek Limited

Web : [www.moduletek.com](http://www.moduletek.com)

Email : [sales@moduletek.com](mailto:sales@moduletek.com)

## Product Selection

Part Number	Description	Color on Clasp
SFP-10G-CWDM-ER-1470-CDR-x-E10	10GBASE CWDM SFP+ Transceiver, LC Connectors, 1470nm, Single Mode Fiber 40km	Gray
SFP-10G-CWDM-ER-1490-CDR-x-E10	10GBASE CWDM SFP+ Transceiver, LC Connectors, 1490nm, Single Mode Fiber 40km	Violet
SFP-10G-CWDM-ER-1510-CDR-x-E10	10GBASE CWDM SFP+ Transceiver, LC Connectors, 1510nm, Single Mode Fiber 40km	Blue
SFP-10G-CWDM-ER-1530-CDR-x-E10	10GBASE CWDM SFP+ Transceiver, LC Connectors, 1530nm, Single Mode Fiber 40km	Green
SFP-10G-CWDM-ER-1550-CDR-x-E10	10GBASE CWDM SFP+ Transceiver, LC Connectors, 1550nm, Single Mode Fiber 40km	Yellow
SFP-10G-CWDM-ER-1570-CDR-x-E10	10GBASE CWDM SFP+ Transceiver, LC Connectors, 1570nm, Single Mode Fiber 40km	Orange
SFP-10G-CWDM-ER-1590-CDR-x-E10	10GBASE CWDM SFP+ Transceiver, LC Connectors, 1590nm, Single Mode Fiber 40km	Red
SFP-10G-CWDM-ER-1610-CDR-x-E10	10GBASE CWDM SFP+ Transceiver, LC Connectors, 1610nm, Single Mode Fiber 40km	Brown

## General Specifications

Parameter	Symbol	Min	Typ	Max	Unit	Remarks
Data Rate	DR	9.95		11.3	Gb/s	1
Bit Error Rate	BER			$10^{-12}$		
Operating Temperature	T <sub>C</sub>	0		70	°C	2, 5
	T <sub>I</sub>	-40		85	°C	2, 6
Storage Temperature	T <sub>STO</sub>	-40		85	°C	3
Supply Current	I <sub>CC</sub>		400	450	mA	4
Input Voltage	V <sub>CC</sub>	3.14	3.3	3.46	V	
Maximum Voltage	V <sub>MAX</sub>	-0.5		4	V	4
Power Consumption	P			1.5	W	

**Notes:**

1. IEEE 802.3ae
2. Case temperature
3. Ambient temperatur
4. For electrical power interface
5. Commercial temperature
6. Industrial temperature

## Link Distances

Data Rate	Fiber Type	Distance Range (km)
9.95~11.3 Gb/s	9/125um SMF	40

## Optical-Characteristics-Transmitter

$V_{CC}=3.14V$  to  $3.46V$ ,  $T_C$

Parameter	Symbol	Min	Typ	Max	Unit	Remarks
Output Optical Power	$P_{TX}$	-4		4	dBm	1
Optical Center Wavelength –1470nm	$\lambda_C$	1465	1471	1477	nm	
Optical Center Wavelength –1490nm		1485	1491	1497	nm	
Optical Center Wavelength –1510nm		1505	1511	1517	nm	
Optical Center Wavelength –1530nm		1525	1531	1537	nm	
Optical Center Wavelength –1550nm		1545	1551	1557	nm	
Optical Center Wavelength –1570nm		1565	1571	1577	nm	
Optical Center Wavelength –1590nm		1585	1591	1597	nm	
Optical Center Wavelength –1610nm		1605	1611	1617	nm	
Optical Modulation Amplitude		OMA	-5.2			
Extinction Ratio	ER	8.2			dB	
Spectral Width (-20dB)	$\Delta\lambda$			0.6	nm	
Side Mode Suppression Ratio	SMSR	30			dB	
Relative Intensity Noise	RIN			-128	dB/Hz	
Transmitter Dispersion Penalty	TDP			2	dB	
Launch Power of OFF Transmitter	$P_{OUT\_OFF}$			-30	dBm	1
Transmitter Jitter	According to IEEE 802.3ae requirement					

### Notes:

1. Average
2. Per IEEE 802.3ae

## Typical eye diagram

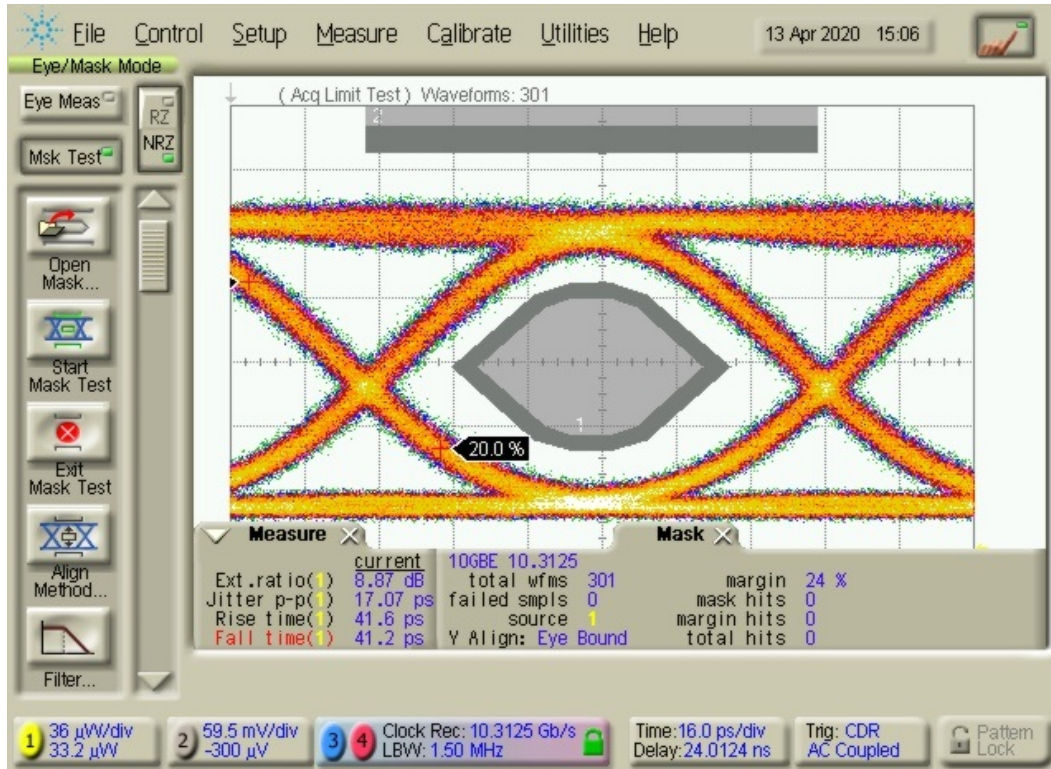

## Optical-Characteristics-Receiver

$V_{CC}=3.14V$  to  $3.46V, T_C$

Parameter	Symbol	Min	Typ	Max	Unit	Remarks
Optical Center Wavelength	$\lambda_C$	1260		1620	nm	
Average Receive Power	$P_{RX}$	-16		0.5	dBm	
Receiver Sensitivity @10.3Gb/s	$R_{X\_SEN}$			-16	dBm	1
Receiver Reflectance	$TR_{RX}$			-27	dB	
LOS Assert	$LOS_A$	-25			dBm	
LOS De-Assert	$LOS_D$			-18	dBm	
LOS Hysteresis	$LOS_H$	0.5			dB	

### Notes:

1. Measured with worst ER:  $BER < 10^{-12}; 2^{31}-1$  PRBS

## Electrical-Characteristics-Transmitter

$V_{CC}=3.14V$  to  $3.46V$ ,  $T_C$

Parameter	Symbol	Min	Typ	Max	Unit	Remarks
Input differential impedance	$R_{IN}$		100		$\Omega$	
Differential data input swing	$V_{IN\_PP}$	120		850	mV	
Transmit Disable Voltage	$V_D$	2		$V_{CC}$	V	
Transmit Enable Voltage	$V_{EN}$	$V_{EE}$		$V_{EE}+0.8$	V	

## Electrical-Characteristics-Receiver

$V_{CC}=3.14V$  to  $3.46V$ ,  $T_C$

Parameter	Symbol	Min	Typ	Max	Unit	Remarks
Differential data output swing	$V_{OUT\_PP}$	300		850	mV	
Data output rise/fall time (20%-80%)	$t_r/t_f$	28			ps	
LOS Fault	$V_{LOS\_A}$	2		$V_{CC\_HOST}$	V	
LOS Normal	$V_{LOS\_D}$	$V_{EE}$		$V_{EE}+0.5$	V	

## A0/A2 Write Protection

Security Level 1 Password		
Password Entry ADDR	Size	Vaules(hex)
Page A2, 7BH-7EH	4	00 00 10 11

This module has the A0 / A2 write protection function. The user can enter the security level 1 working state and write the contents of Table 00 and Table 01 of the device address A0H and A2H of the module. The method to enter the working state of security level 1 is to write the security level 1 password in order in the 7BH-7EH registers of A2H of the module. After entering security level 1, the user can directly write to the contents of the A0H device address, or modify the contents of the A2H 7F table selection register to write to the contents of Table 00 or Table 01. This version of the module does not support users to modify the password of security level 1. If you need to modify the security level 1 password, you must notify our company to modify it before shipping.

## I2C Memory Map(Page A0 HEX,Unlisted Fields are Blank/Empty)

IIC ADDR	Size	Name	Description	Vaules(HEX)
0	1	Identifier	SFP	03
1	1	Extended Identifier	Extended Identifier	04
2	1	Connector	Connector Type=LC	07
3-10	8	Transceiver	10G Base ER	80 00 00 00 00 00 00 00
11	1	Encoding	Code for high speed serial encoding algorithm	03
12	1	BR,Nominal	Nominal Bit Rate 10.3Gb/s	67
13	1	Rate Identifier	Type of rate select functionality	00
14	1	Lenth(9μm)-km	40km Link Length in Thousands of Meters / SMF	28
15	1	Lenth(9μm)-100m	9-micron MMF Link Length	FF
16	1	Lenth(50μm)-10m	50-micron MMF Link Length = N/A	00
17	1	Lenth(62.5μm)-10m	62.5-micron MMF Link Length = N/A	00
18	1	Lenth(Copper)	Copper Link Length = N/A	00
19	1	Reserved	Reserved	00
20-35	16	Vendor name	ModuleTek	ASCII Format
36	1	Transceiver	Code for electronic or optical compatibility	00
37-39	3	Vendor OUI	SFP Vendor IEEE Company ID	ASCII Format
40-55	16	Vendor PN	The Part number in the Ordering Information	ASCII Format
56-59	4	Vendor Revision Number	Vendor Revision Number	Programmed by Factory
60-61	2	Wavelength	Wavelength	according to actual wavelength
62	1	Reserved	Reserved	00
63	1	CC_BASE	Check sum of bytes 0-62	Programmed by Factory
64-65	2	Transceiver Options	1.Rx_LOS 2.Tx_FAULT 3.Tx_DIS	00 1A
66	1	BR, max	Upper bit rate margin	00
67	1	BR, min	Lower bit rate margin	00

68-83	16	Vendor SN	Vendor SN	Programmed by Factory
84-91	8	Date code	Year,Month,Day	Programmed by Factory
92	1	Monitoring Type	Internally Calibrated Received power measurement type-Average Power	68
93	1	Enhanced Options	1. Optional Alarm/Warning Flags Implemented 2. Soft Tx_ DIS Monitor and Control 3. Soft Rx_ LOS Monitor 4.Soft Tx_ FAULT Monitor	F0
94	1	SFF-8472 Compliance	Indicates which revision of SFF-8472 the transceiver complies with	08
95	1	CC_EXT	Check sum of bytes 64-94	Programmed by Factory
96-127	32	Vendor Specific	Vendor Specific EEPROM	Programmed by Factory
128-255	128	Vendor Specific	Vendor Specific	Programmed by Factory

## Digital Diagnostic Functions

SFP-10G-CWDM-ER-xxxx-CDR-x-E10 supports the 2-wire serial communication protocol as defined in SFF-8472. Digital diagnostic information is accessible over the 2-wire interface at the address 0xA2. Digital diagnostics for SFP-10G-CWDM-ER-xxxx-CDR-x-E10 are internally calibrated by default. The internal micro control unit accesses the device operating parameters in real time, Such as transceiver temperature, laser bias current, transmitted optical power, received optical power and transceiver supply voltage. The module implements the alarm function of the SFF-8472, alerts the user when a particular operating parameter exceeds the factory-set normal range.

Digital Diagnostic Threshold Range					
Parameter		High Alarm	High Warning	Low Warning	Low Alarm
Temperature(°C)	C	75 (0x4B00)	70 (0x4600)	0 (0x0000)	-5 (0xFB00)
	I	90 (0x5A00)	85 (0x5500)	-40 (0xD800)	-45 (0xD300)
Voltage (V)		3.63 (0x8DCC)	3.46 (0x8728)	3.13 (0x7A44)	2.97 (0x7404)
Bias Current (mA)		100 (0xC350)	95 (0xB98C)	20 (0x2710)	15 (0x1D4C)
Tx Power (µW)		3014.2 (0x75BE)	2511.8 (0x621E)	316.2 (0x0C5A)	252.9(0x09E1)
Rx Power (µW)		2000 (0x4E20)	1500 (0x3A98)	23.7 (0x00ED)	15.8 (0x009E)



## Block-Diagram-of-Transceiver

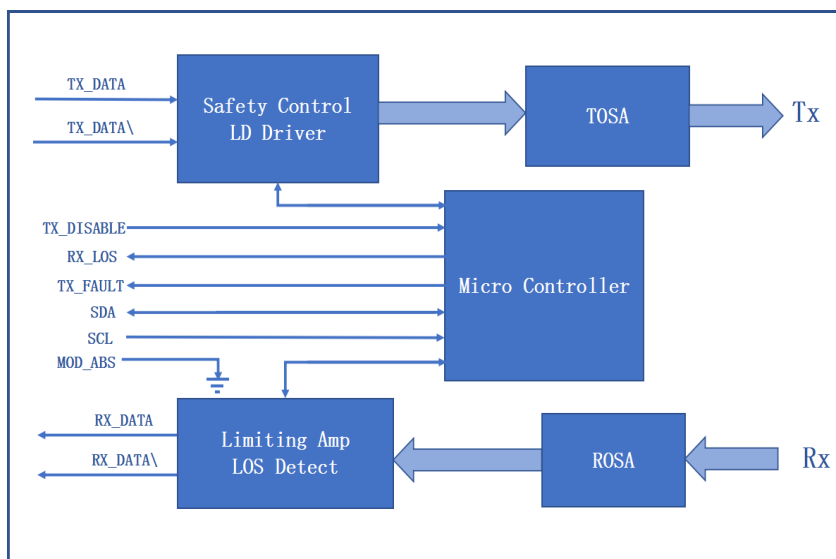

## Functions Description

The transmitter consists of a laser driver chip and a TOSA (light-emitting component). The TOSA includes a DFB laser, an electroabsorption modulator (EAM), a TEC, and a backlight diode. Unlike DML, EML TOSA uses external modulation. When the transmission rate of the system is high, the transmission distance is not only limited by the attenuation of the optical fiber, but also by the dispersion of the optical fiber, and the dispersion of the optical communication system is related to the modulation spectral width. The directly modulated laser has a large dispersion cost, and has spectral broadening, frequency chirp, and short transmission distance, so the external modulation method is adopted in the medium-long-distance transmission at a rate of 10 Gb/s. TEC (Thermo Electric Cooler) Controls the temperature of the laser tube. When a temperature is set, the TOSA temperature of the module will remain unchanged through the control of the TEC. The wavelength of the module laser tube is related to the temperature of the laser tube. The module wavelength can be set by setting the TOSA temperature. When stable, the module has excellent wavelength stability. The electrical signal enters the optical module from the serial electrical interface and is then input to the laser driver chip. The laser driver chip supplies the bias current and the modulation current to the laser. The laser driver chip simultaneously uses an automatic optical power control (APC) feedback loop to maintain a constant average optical power of the laser output. The purpose is to eliminate the change of the output optical signal due to temperature changes and aging of the light source device. When the transmitter enable pin (TX\_Disable) is high (TTL logic "1"), the laser output is turned off. When TX\_Disable is low (TTL logic "0"), the laser will turn on within 1ms. When the transmitter fault signal (TX\_Fault) is reported as high, indicates a transmitter failure caused by the transmitter's bias current or transmitted optical power or laser tube temperature exceeding a preset alarm threshold. Low indicates normal operation.

The receiver consists of a ROSA (light-receiving component) and a limiting amplifier chip, ROSA includes a PIN photodetector and a transimpedance amplifier chip. The ROSA detects the incident optical signal, converts the optical signal into an electrical signal and outputs the electrical signal to the

limiting amplifier. The electrical signal is further amplified by the limiting amplifier, then outputs a fixed-amplitude electrical signal to the host. When the amplitude of the electrical signal received from the incident light conversion of the opposite optical transceiver module is lower than the set threshold, the module reports that the received signal is lost, the RX\_LOS pin is high (logic "1"), which can be used to diagnose whether the physical signal is normal. The signal is operated in TTL level. The microprocessor inside the module monitors the module's operating voltage, temperature, transmitted optical power, received optical power, and laser bias current value in real time. The host acquires this information over a 2-wire serial bus.

## Dimensions

**Module Weight: 16.5g**

**Dust Cap Weight: 0.95g**

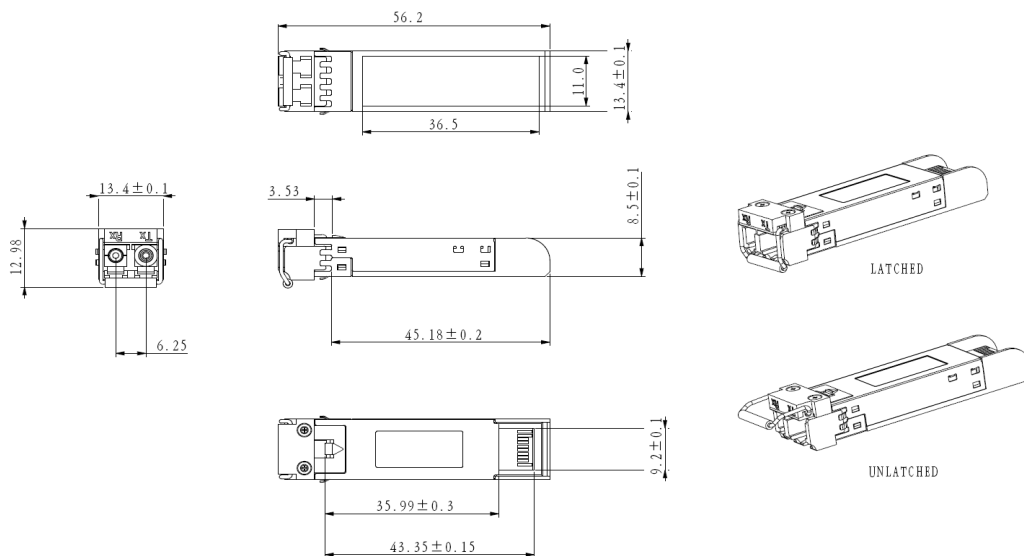

ALL DIMENSIONS ARE ±0.2mm UNLESS OTHERWISE SPECIFIED  
UNIT: mm

## Electrical Pad Layout

Top of Board

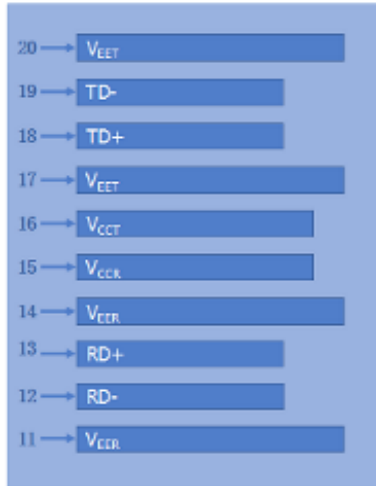

Bottom of Board

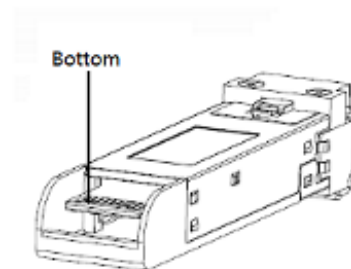
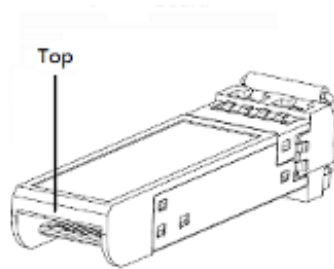
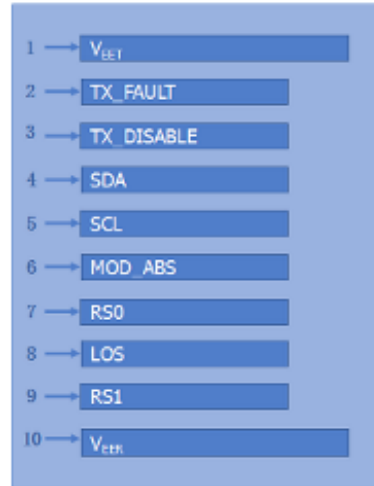

## Pin Assignment

PIN #	Symbol	Description	Remarks
1	V <sub>EET</sub>	Transmitter ground (common with receiver ground)	1
2	TX_FAULT	Transmitter Fault	
3	TX_DISABLE	Transmitter Disable. Laser output disabled on high or open	2
4	SDA	2-wire Serial Interface Data Line	3
5	SCL	2-wire Serial Interface Clock Line	3
6	MOD_ABS	Module Absent. Grounded within the module	3
7	RS0	No connection required	
8	LOS	Loss of Signal indication. Logic 0 indicates normal operation	4
9	RS1	No connection required	1
10	V <sub>EER</sub>	Receiver ground (common with transmitter ground)	1
11	V <sub>EER</sub>	Receiver ground (common with transmitter ground)	1
12	RD-	Receiver Inverted DATA out. AC coupled	
13	RD+	Receiver Non-inverted DATA out. AC coupled	
14	V <sub>EER</sub>	Receiver ground (common with transmitter ground)	1
15	V <sub>CCR</sub>	Receiver power supply	
16	V <sub>CCT</sub>	Transmitter power supply	
17	V <sub>EET</sub>	Transmitter ground (common with receiver ground)	1
18	TD+	Transmitter Non-Inverted DATA in. AC coupled	
19	TD-	Transmitter Inverted DATA in. AC coupled	
20	V <sub>EET</sub>	Transmitter ground (common with receiver ground)	1

### Notes:

1. Circuit ground is isolated from chassis ground
2. Disabled: T<sub>DIS</sub>>2V or open, Enabled: T<sub>DIS</sub><0.8V
3. Should Be pulled up with 4.7k –10k ohm on host board to a voltage between 2V and 3.6V
4. LOS is open collector output

## References

1. IEEE standard 802.3ae. IEEE Standard Department, 2005.
2. Enhanced 8.5 and 10GBASE Small Form Factor Pluggable Module "SFP+" — SFF-8431.
3. Digital Diagnostics Monitoring Interface for Optical Transceivers — SFF-8472.